

SL-T3020PDB020-L285-E

PHOTO Diode

DATA SHEET

SPEC. NO. : SZ20041803
DATE : 2020/04/18
REV. : Temporary Version

Approved By:

Checked By:

Prepared By:

Features

- ◆ Pb free product—RoHS compliant
- ◆ High Photo Sensitivity
- ◆ Reliable and rugged
- ◆ Long life – solid state reliability
- ◆ Sensitivity angle: 90°

Package Dimension

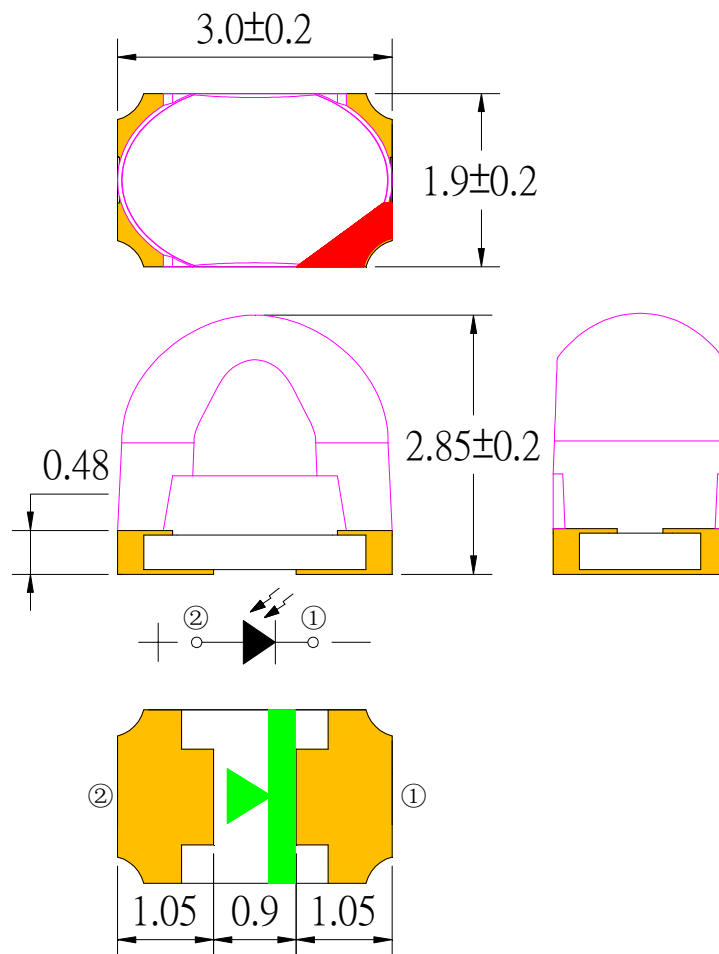

Part NO.	Chip Material	Lens Color
SL-T3020PDB020-L285-E	Silicon	Black

Notes:

1. All dimensions are in millimeters.
2. Tolerance is ± 0.10 mm unless otherwise noted.
3. Specifications are subject to change without notice.

Absolute Maximum Ratings at Ta=25°C

Parameter	Maximum Rating	Unit
Power Dissipation	150	mW
Reverse Voltage	30	V
Electrostatic Discharge (HBM) ^{*4}	2000	V
Moisture Sensitivity Level ^{*1}	3	
Operating Temperature	-40°C ~ +85°C	
Storage Temperature Range	-40°C ~ +100°C	
IR Reflow Temperature ^{*3}	260°C for 10 Seconds MAX.	

1. Storage:

- (1). Storage requirements before vacuum bag opened: Temperature<30°C, Humidity<65%RH;
- (2). Check air leakage and vacuum bag damage before opened. If there is any issue found, check the humidity indicator card immediately after bag opened:
 - a. If color changes on “10% circle” of the humidity indicator card only and not the circles of 20% and above, components can be used without additional handling;
 - b. If color changes on both 10% and 20% circles but not the circles of 30% and above, components must be dehumidified according to the conditions of bullet (5);
 - c. If color changes on 10%, 20%, and 30% circle or above, the product should be returned to the supplier for high temperature dehumidification;
- (3). After bag opened, manual soldering or reflow process must follow the following requirements:
 - a. Complete soldering / reflow within 168 hours;
 - b. Requirements of working environment: Temperature<30°C, Humidity<60%RH;
- (4). If the working condition is outside (3)a or (3)b requirement, the components must be dehumidified according to the conditions of bullet (5);
- (5). Low temperature dehumidification: temperature 60±5°C, 24 hours;
- (6). Shelf life: 30 days. If it's over 30 days from the production date on the package label, the components must be dehumidified according to the condition of bullet (5). If customer is unable to dehumidify, return components to LIGHT for dehumidification.

2. Cleaning:

Use alcohol-based cleaning solvents such as isopropyl alcohol to clean the LED if necessary.

3. IR Reflow Temperature:

It is the Plate Temperature.

4. Caution in ESD:

Static Electricity and surge damages the LED. It is recommend to use a wrist band or anti-electrostatic glove when handling the LED. All devices, equipment and machinery must be properly grounded.

Electrical Optical Characteristics at Ta=25°C

PARAMETER	SYMBOL	MIN.	TYP.	MAX.	UNITS	TEST CONDITIONS
Reverse Light Current	I_L	15.5	20	---	μA	$V_R=5\text{V}$ $E_e=1\text{mW}/\text{cm}^2$ $\lambda_p=940\text{nm}$
Reverse Dark Current	I_D	---	---	100	nA	$V_R=10\text{V}$ $E_e=0\text{mW}/\text{cm}^2$
Reverse Voltage	$V_{(R)}$	30	---	---	V	$I_R=100\mu\text{A}$
Forward Voltage	V_F	---	---	1.5	V	$I_F=20\text{mA}$
Viewing Angle(X)	$2\theta_{1/2}$	80	90	100	Deg.	(Note 1)
Viewing Angle(Y)	$2\theta_{1/2}$	25	30	35	Deg.	
Rise Time/ Fall Time	tr/ tf	---	50	---	ns	$V_R=10\text{V}$ $R_L=1\text{k}\Omega$
Total Capacitance	C_T	---	12	---	pF	$V_R=5\text{V}$ $E_e=0\text{mW}/\text{cm}^2$ $f=1.0\text{MHz}$

Note:

- $\theta_{1/2}$ is the off-axis angle at which the Reverse Light Current is half the axial Reverse Light Current.
- The I_L guarantee should be added $\pm 15\%$ tolerance.

Typical Electrical / Optical Characteristics Curves (25°C Ambient Temperature Unless Otherwise Noted)

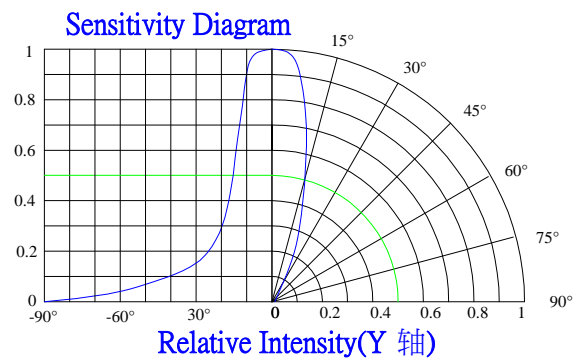
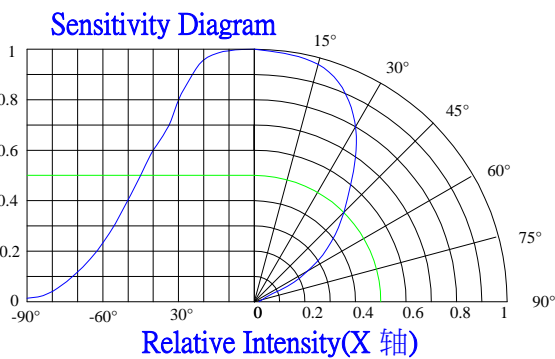
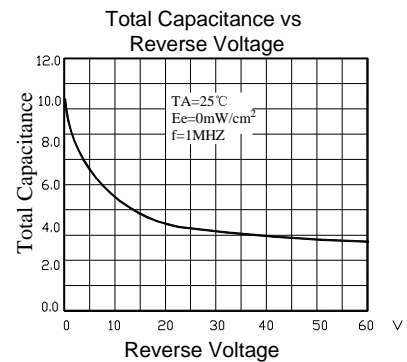
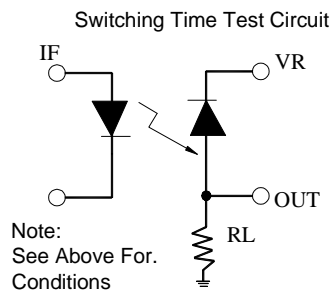
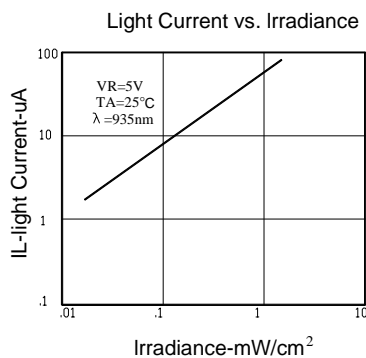
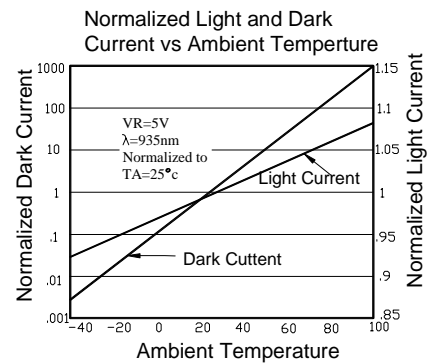
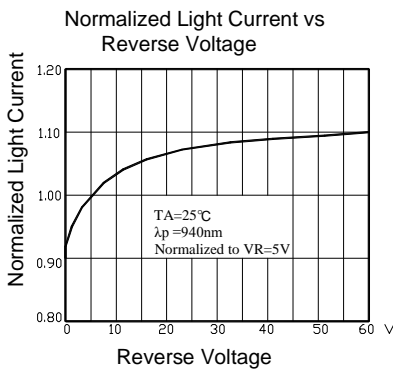
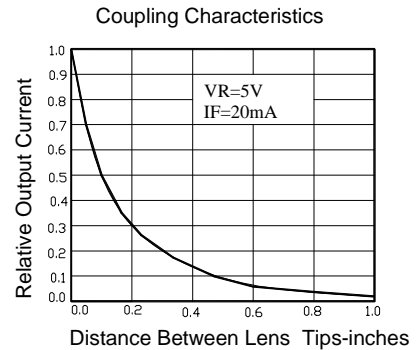
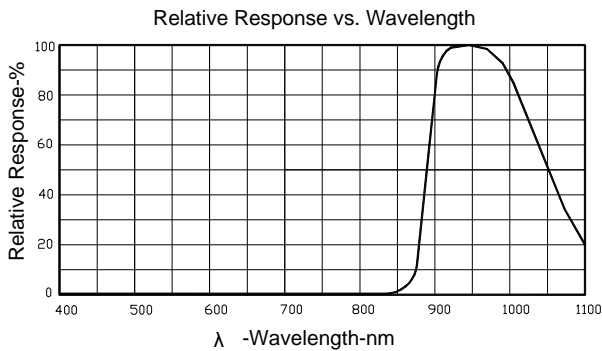

Infrared Photo Diode Specification

●Commodity: Infrared Photo diode

●Reverse Light Current Bin Limits

BIN CODE	Min.(μ A)	Max.(μ A)
29	15.5	18.5
30	18.5	22
31	22	26

NOTE: The I_L guarantee should be added $\pm 15\%$ tolerance.

Label Explanation

LIGHT Universal Label

LIGHT 深圳莱特光电股份有限公司  Light Electronics CO., LTD.	
产品型号 MODEL NAME:	 LOT NO.:
数量 QUANTITY:	
等级 BIN:	
包装日期 PACKING DATE:	
备注 REMARKS:	

Customer Defined Label

LIGHT 深圳莱特光电股份有限公司  Light Electronics CO., LTD.	
产品型号 MODEL NAME:	 LOT NO.:
数量 QUANTITY:	
等级 BIN:	
包装日期 PACKING DATE:	
客户料号 CUSTOMER P/N:	

MODEL NAME/产品型号	QUANTITY/包装数量
BIN./分光等级	PACKING DATE/包装日期
CUSTOMER P/N/客户料号	LOT NO./生产批号
REMARKS/备注	/

Reel Dimensions

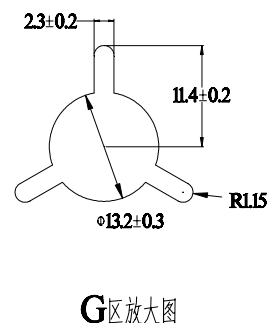
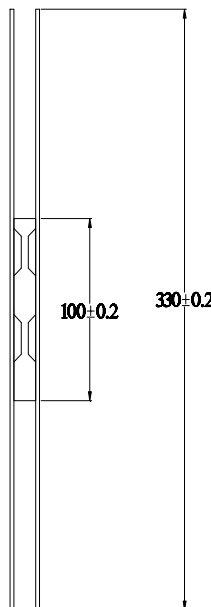
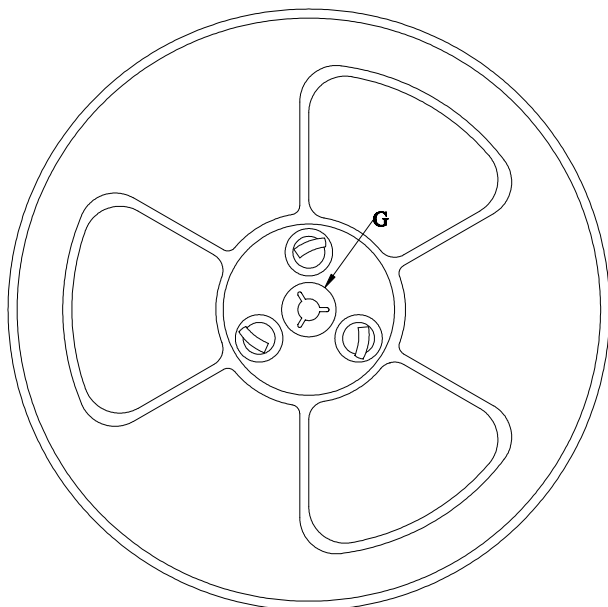

Note: Tolerance unless mentioned is $\pm 0.2\text{mm}$; Unit = mm

Carrier Tape Specifications (Loaded Quantity: 5000pcs/reel)

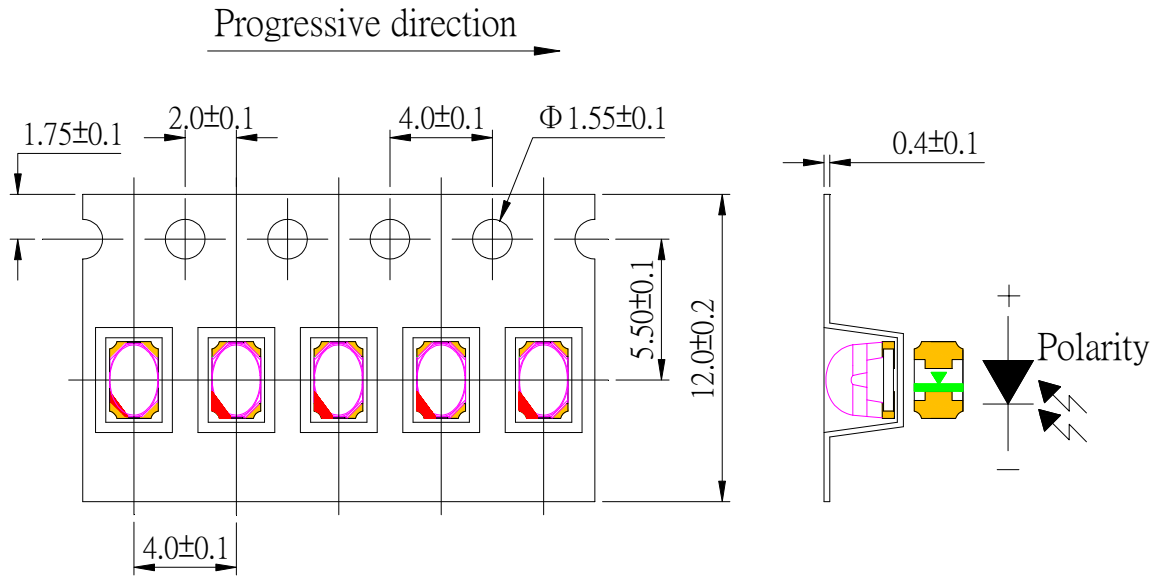

Note: Tolerance unless mentioned is ±0.1mm; Unit = mm

Moisture Resistant Packaging

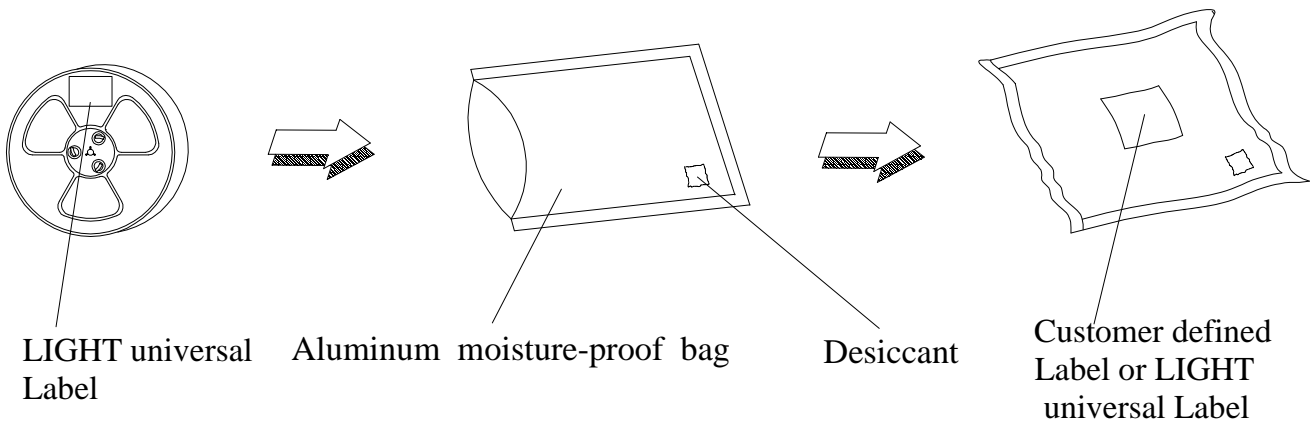

Suggest IR Reflow Condition For Lead Free

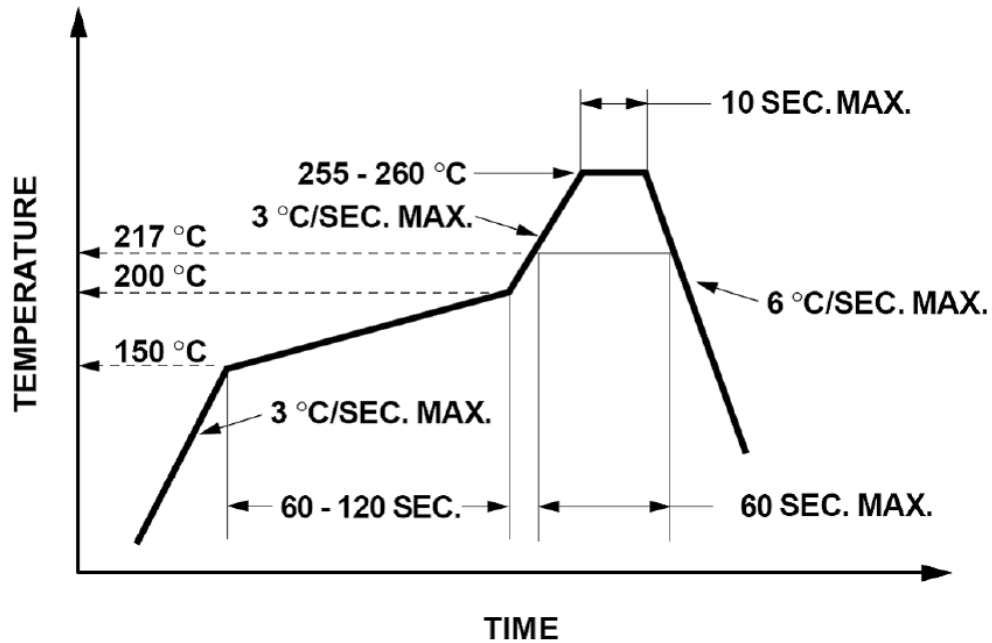

1. Reflow soldering should not be done more than two times.
2. When soldering, do not put stress on the LEDs during heating.

Soldering iron

1. When hand soldering, the temperature of the iron must less than 300 °C for 3 seconds.
2. The hand solder should be done only once.

Repairing

Repair should not be done after the LEDs have been soldered. When repairing is unavoidable, a double-head soldering iron should be used (as below figure). It should be confirmed beforehand whether the characteristics of LEDs will or will not be damaged by repairing.

